

SWITCHING DIN SYNC JACK

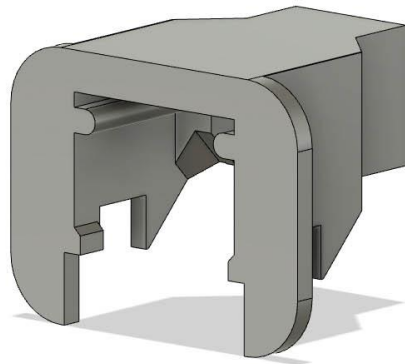

ASSEMBLY
+
INSTALLATION

SAN FRANCISCO SYNTHWORKS

<https://sfsynthworks.com>

WARNING:

San Francisco Synthworks LLC shall not be held liable for any improper or incorrect use of the information described and/or contained herein and assumes no responsibility for anyone's use of the information.

In no event shall San Francisco Synthworks LLC be liable for any direct, indirect, incidental, special, exemplary, or consequential damages (including, but not limited to, procurement or substitute goods or services; loss of use, data, or profits; or business interruption) however caused and on any theory of liability, whether in contract, strict liability, or tort (including negligence or otherwise) arising in any way out of the use of this product, even if advised of the possibility of such damage.

This disclaimer of liability applies to any damages or injury, including but not limited to those caused by any failure of performance, error, omission, interruption, deletion, defect, delay in operation or transmission, computer virus, communication line failure, theft or destruction or unauthorized access to, alteration of, or use of record, whether for breach of contract, tortious behavior, negligence or under any other cause of action.

INDEMNIFICATION:

User agrees to defend, indemnify, and hold harmless San Francisco Synthworks LLC and their respective directors, officers, employees, and agents from and against all claims and expenses, including attorneys' fees, arising out of the use of our products.

3D Printed Parts:

There are two 3D printed parts, the housing and the switch actuator:

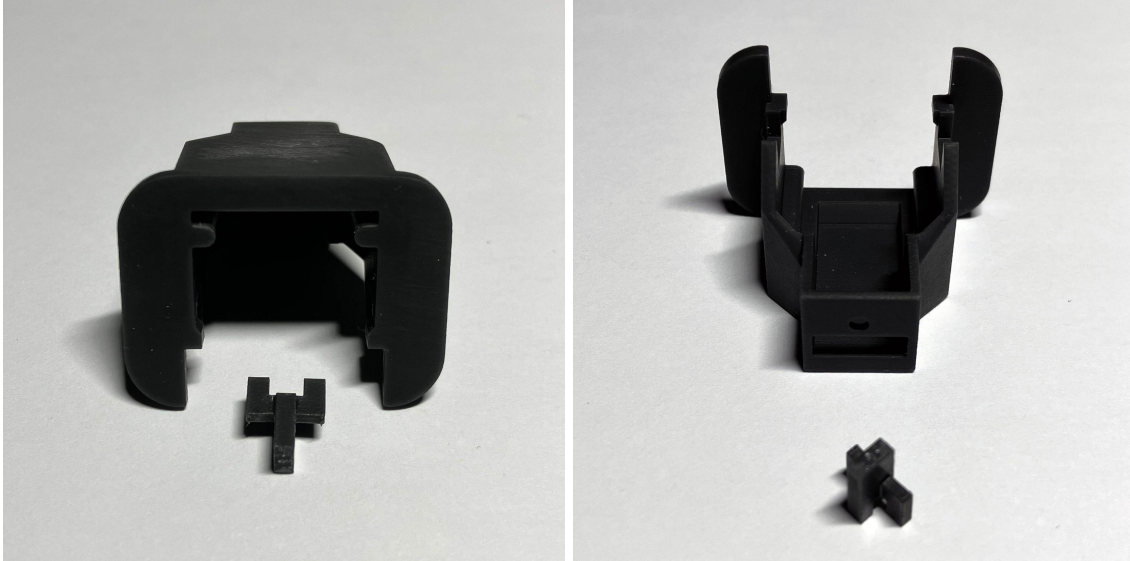

Other Parts:

There are two other parts required, the DIN 5 jack and the momentary switch:

- Switch: Alps Alpine SPVQ910205
- DIN 5 Jack: Multicomp PSG03463

Assembly:

1. Disassembly and modify the DIN 5 jack as shown in the picture. The left side is unmodified and the right side is modified. The face of the jack needs to be removed, and the base needs to have the corners trimmed.

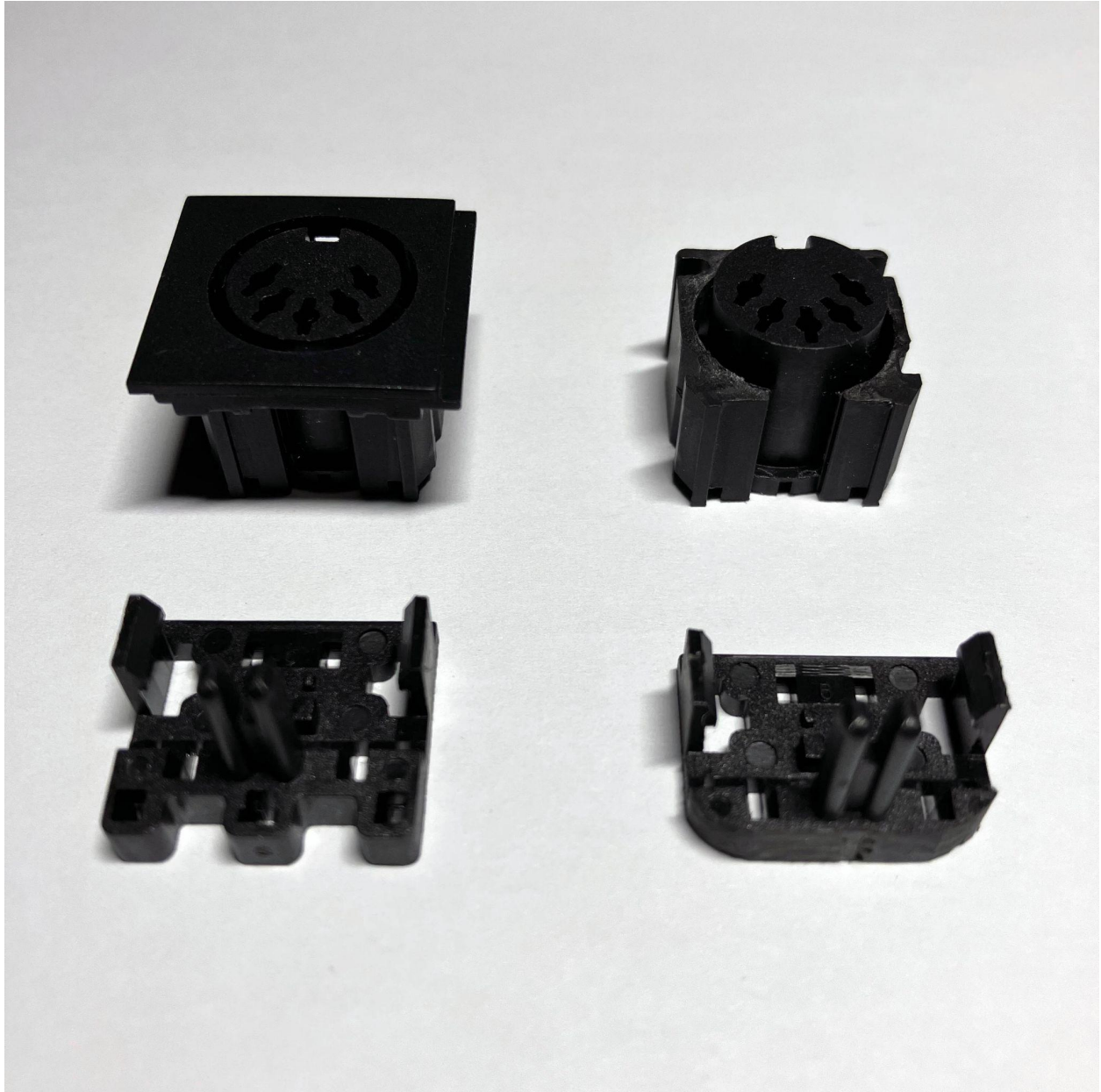

2. With the jack facing down, install the pins and the actuator from the back. Then carefully install the 3D printed base to the back - but do not press it down fully.

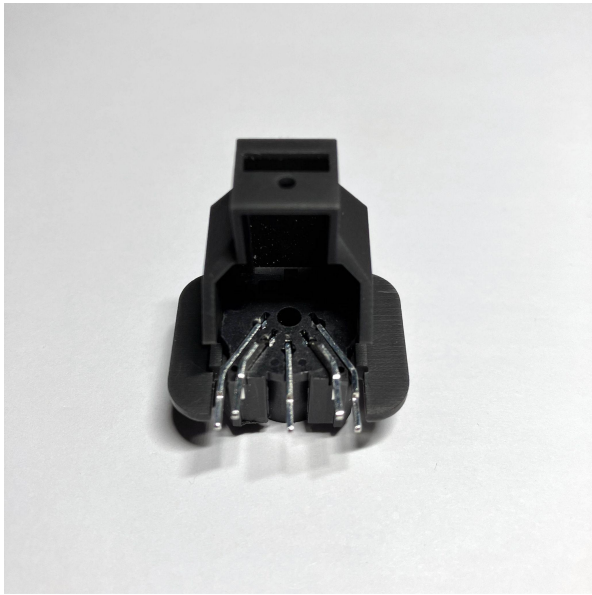
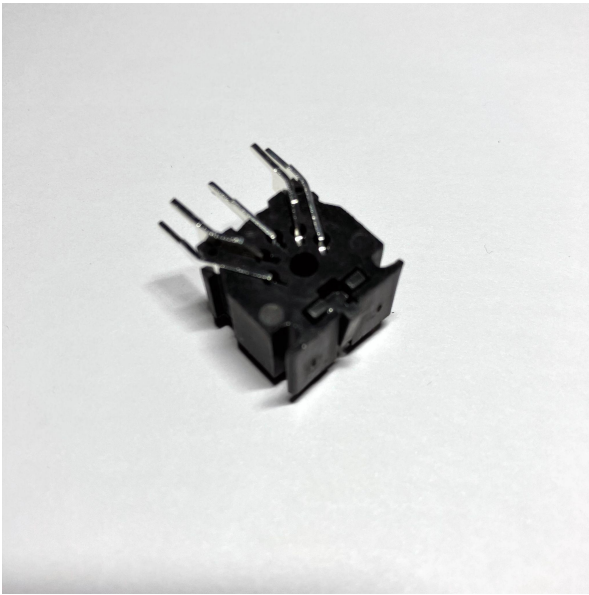

3. Cut the middle two leads on the back of the switch, we don't need them for this application.



4. Rotate the jack so that the top is facing down and install the switch. Slide the housing full on.

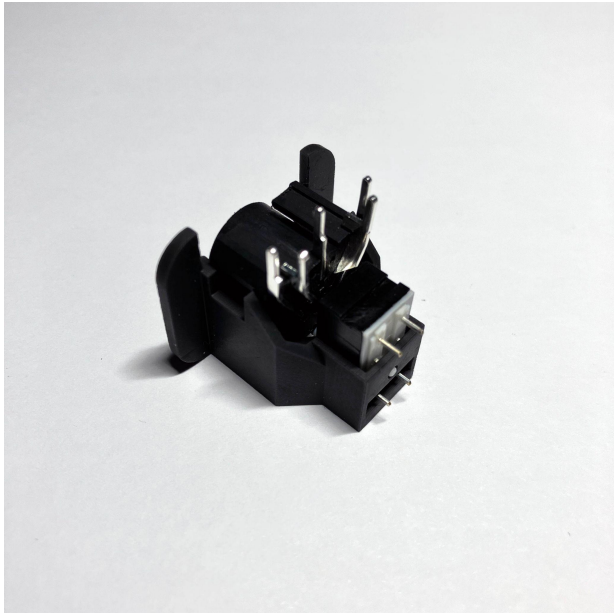

5. Install the base to lock everything in place. Bend the bottom leads to the left as shown to clear the nearby IC if you have socketed it.

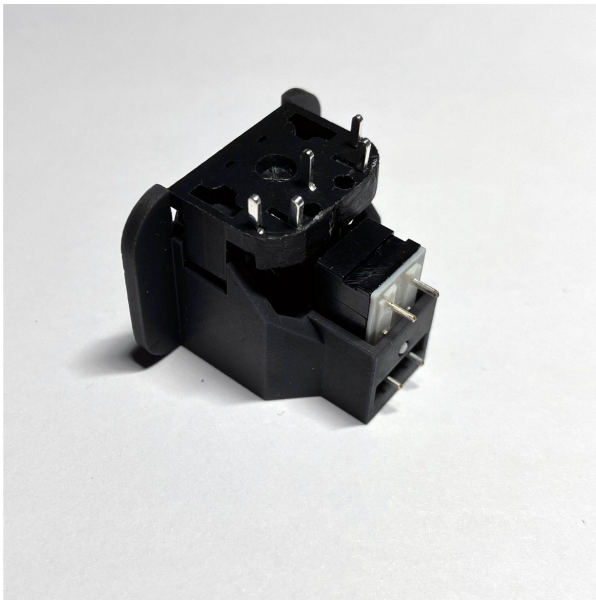

6. Solder 4 short leads to the pins of the switch, use shrink tube to protect from short-circuits with surrounding parts.

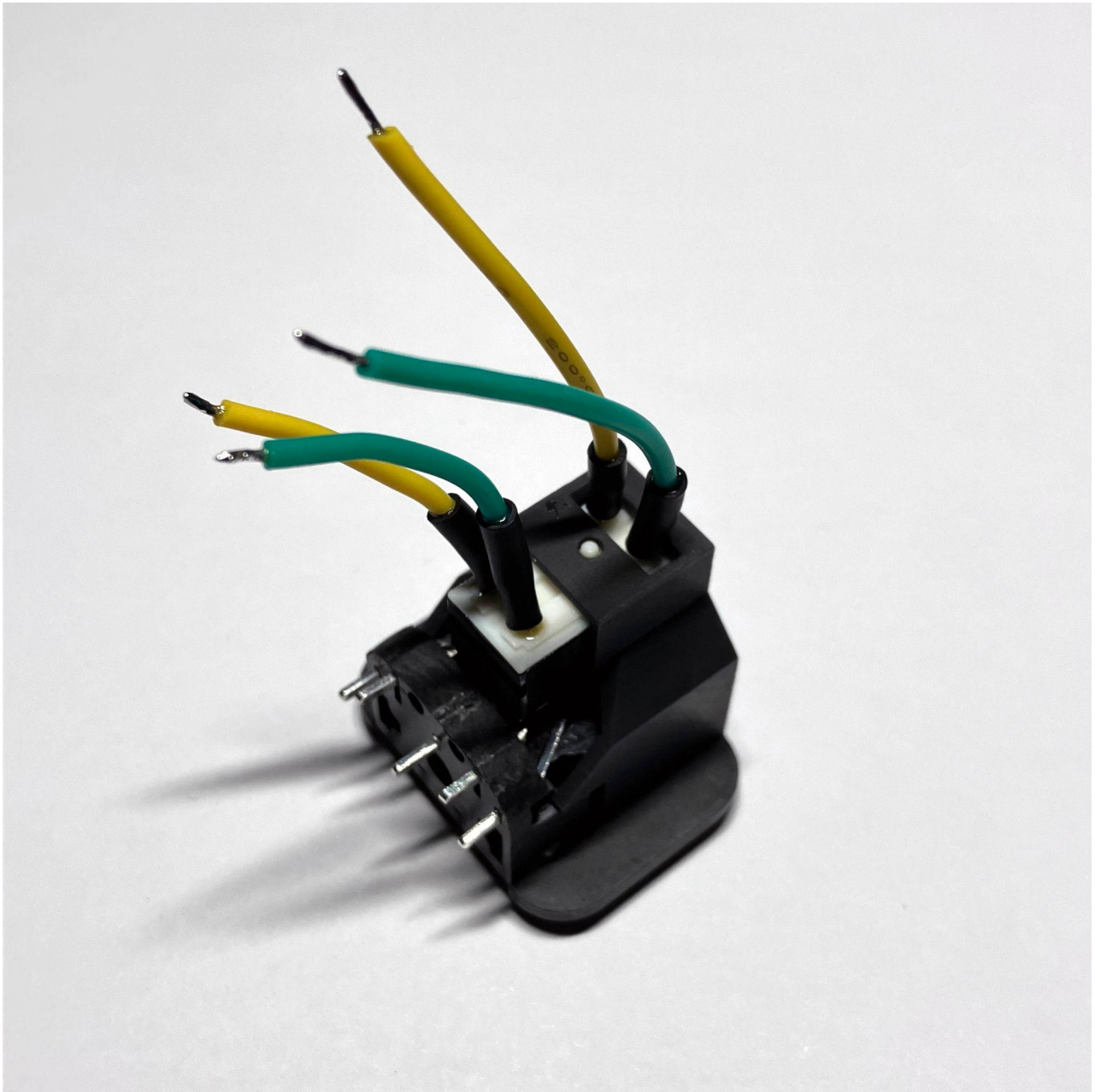

7. Solder the wires to the board first and then the jack itself.

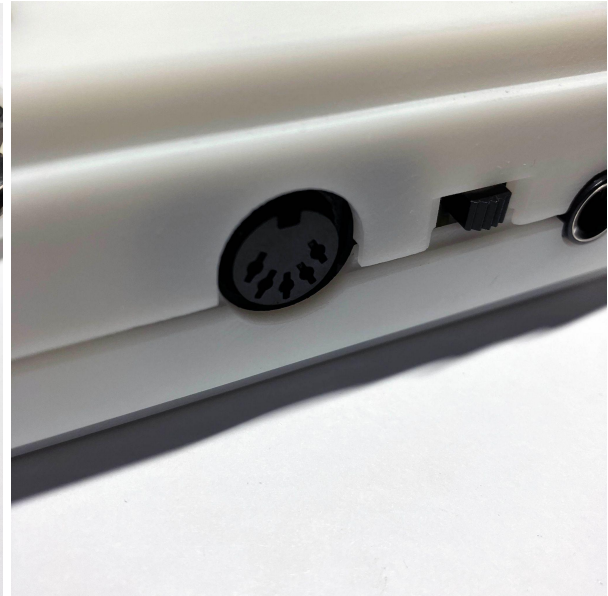
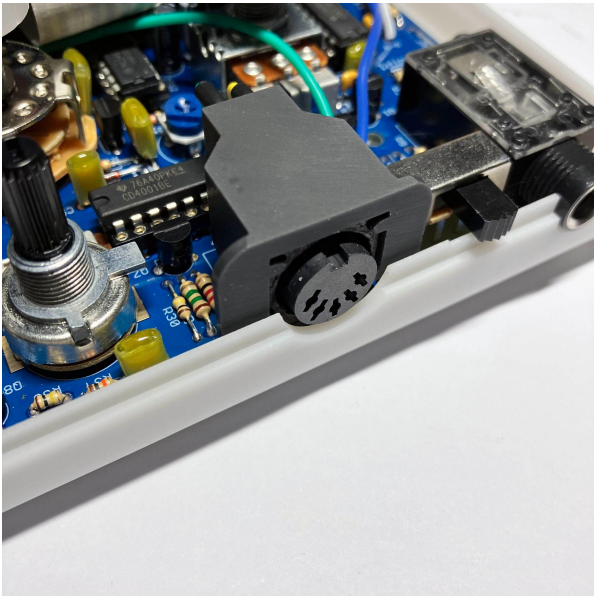
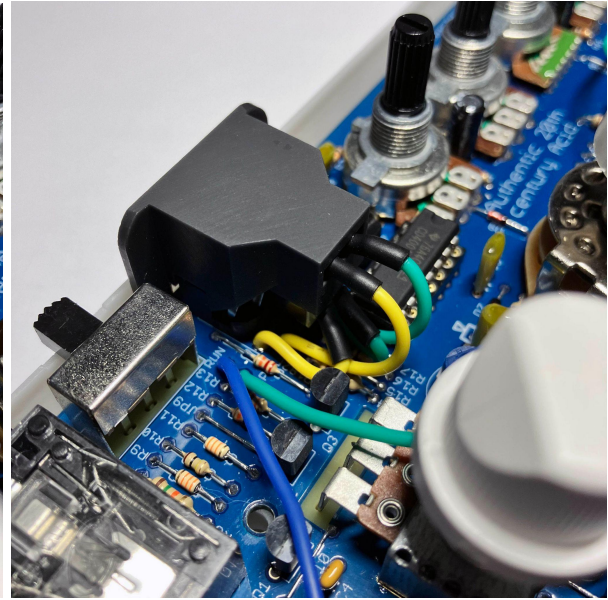
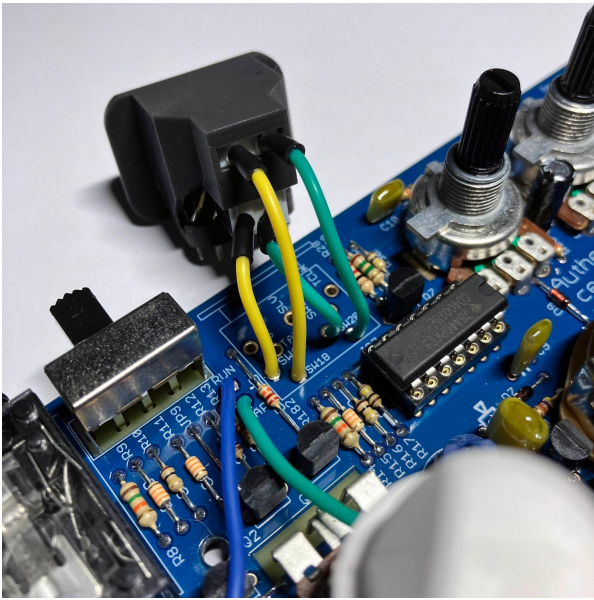

This design was heavily influenced by the wonderful work by K. Gibson. We used the same donor parts as the original design but created a new housing.

Thank you!

If you have any questions, please feel free to reach us on instagram [@sfsynthworks](#) or email at contact@sfsynthworks.com

SAN FRANCISCO SYNTHWORKS